



FREY
Maschinenbau



F-Line F100 - F200

Professional vacuum stuffers for the trade and industry

F-LINE F100-F200 are designed as vacuum fillers for the trades and industrial production sites. F100-F200 are for productions with high demands on the exactness of the portions and the quality. F100-F200 masters every kind of filling such as straight-filling, portioning and linking.

F-Line F100-F200 - Innovative conveyor technology



Rotary systems

Frey uses large-dimensioned vane cell feeding systems with 14 filling chambers in the F-Line F100-F200 vacuum fillers. With the Peek-Cam-system a material combination is used which concentrates the wearing out on only one part of the rotor system and ensures a higher service life.

The guide core is pluggable and can therefore be exchanged without tools. The rotor system works with highest portioning exactness and the new geometry of the chambers ensures an optimum sucking of the filling material. The result is an optimum sausage aspect, also of critical sorts. In connection with the most modern FREY- control and drive technology the rotor system of the F-Line F100-F200 achieves highest portioning exactness, also by producing high quantities. The maximum portioning speed is approx. 600 port./min.

The F-Line F100-F200 achieves a filling performance from 3.000 kg/h to max. 4.200 kg/h and a filling pressure up to 55 bar. The F-Line F100-F200 is the most powerful filling machine in this segment. The model F-Line WK is designed for applications with the grinding head systems WK98 / WK132. F-LINE F100-F200 manages to do portioning and linking with different casings such as natural and artificial casings, tins or as leading pump for attachments.



Flexibility

Is a catchword in our time. The customer of today expects a larger product diversity than in former times. With F-Line F100-F200 you are well prepared for the future. The FREY vane cell pump guarantees an especially high care for the sausage meat. You can fill all kind of sausages - independent on the sausage meat - e.g. warm and liquid liver sausage, sausage with big meat pieces, tough raw sausage meat at minus degrees, you always get the highest quality of your products. An easy conversion to fill products with big pieces is always possible. On special request rotors with a reduced number of wings and a bigger volume of the chambers are available.

Clear advantages for F-Line users

- Best product quality due to the large dimensions of the FREY meat pump
- Constructed according to the „Hygienic Design“ guidelines
- Excellent price-performance ratio
- High filling power
- Low maintenance costs due to the maintenance-free servo-drive
- Fast and easy change of sorts
- Low noise level due to the FREY servo-drive
- High energy efficiency thanks to the most modern control and drive technology
- Easy cleaning of the vacuum system
- Multiple combinations with C-LINE accessories and external devices.



F-Line F100 hopper

F-LINE F100/103 is delivered with a non-divisible hopper of 120 liters. The spiral stirrer can be dismantled and therefore fulfills all hygienic requirements. Optionally available with a divisible hopper.

Drive technology of the future

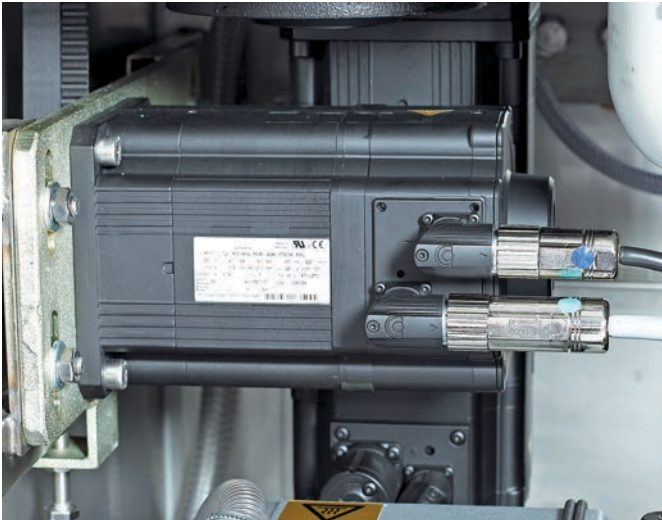

Servo-drive with positioning controller

The servo-drive with positioning controller is trend-setting. This drive technology enables highest portioning accuracy.

It is to be distinguished by a high moment of rotation and a quick reaction. The linking process is concipated extremely dynamically due to an accordant programming of the drive parameters. Also with a very high working speed the machine cares for the sausages during the linking process. So e.g. the acceleration of the rotor system during the start and stop process can individually be adjusted. Depending on the conveyor system the spiral stirrer is driven by a drive with firm gear transmission. Thus, the rotational speed is adapted to the filling speed.

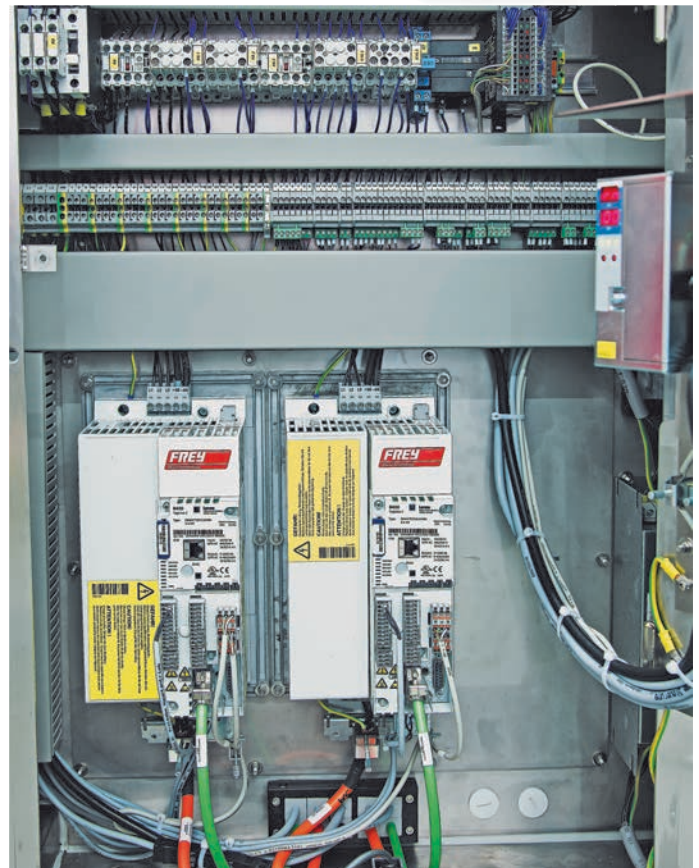

Optionally available is a servo linking motor instead of the usual linking motor. The servo linking motor is distinguished by a higher dynamics and a more precise linking. The servo linker is also used for the drive of the grinding head system WK98. The noise level of the machine is extremely low. Due to the high efficiency the F-Line is extremely energy efficient. Considering the increasing energy prices a lower consumption of energy becomes more and more important. This kind of drive unit is especially wear-resistant and maintenance-free as only few mechanical components are installed. The servo positioning controllers are situated separately and thermally apart of the machine. Simple and safe connection of all additional appliances at a strike guarded place. The digital drive and communication between the FREY-filler touch control and external devices with CAN-Bus system ensure highest processing security.

Convincing ergonomic details

Cleaning and hygiene

A simple cleaning is the basic requirement for best hygienic conditions in the production. FREY-stuffers therefor have smooth external contours. F-Line F-Line F100/103, F160/163, F190/193 und F200 are conforming to the CE-regulations. The splash and strike guard, which can be taken off, serves as additional protection to avoid damages made by the cleaning personal and pointed tools. The machine housing is completely made of high-quality stainless steel. The expenditure for cleaning and maintenance is very low due to the easy disassembling of the parts of the rotor system and neat contours between the parts.

Ergonomic operation

The operating zone and the HMI of the control have been arranged with a big operating comfort. The vacuum window is situated in the field of vision and in the working zone. By activating a vacuum valve, situated in the cover, the vacuum channel is being automatically cleaned.



Linking gear

F-LINE F100-F200 is now equipped with a linking gear without limits for your production. It has especially been developed for the industry and has just proved itself. High-power toothed belts care for a maintenance free operation. For filling big diameters you can easily take off the linking gear by means of a quick-closing. Thereby, the way of the sausage meat is shortened and the greasing is minimized.

Additional appliances

F-Line F100-F200 can flexibly be used, semi or fully automatic clipping machines can be adapted. In connection with the conveyor linking system BASo2/SA / KAS and the automatic hanging line AHL02 the performance of the sausage production can enormously be increased.

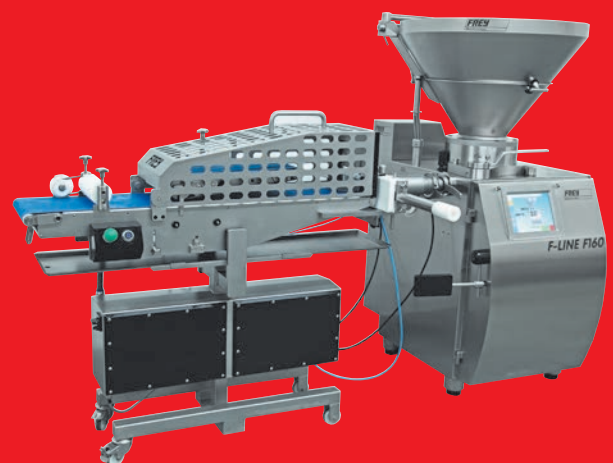



Powerful, practical and conforming to CE- standard

Target groups F-Line F100/103 F160/163:

- *Handcraft to medium-sized productions*
- *Users of half-automatic clipping machines*
- *Production of sausages*
- *Suitable for small calibrated products, which need a high filling pressure*
- *Productions with attachments demanding high conveying capacity*
- *Productions with high demands on the exactness of the portions and the quality*
- *Filling & portioning of convenience products*



Lifting device

F-LINE F160-F200 can be delivered with or without a hydraulic lifting device for standard trolleys. The stirring device, which is controlled by the transporting capacity and the meat guiding in the neck of the hopper, ensure a continuous charging of the rotor chambers. A fast emptying of the machine as well as a quick change of sorts is guaranteed.

F160 - filling hopper

F-Line F160/163 is delivered with a 160-liters-hopper which is usually charged by means of a lifting and dumping device. For cleaning purposes the foot step can be tilted out. The contents of the hopper of F190/193/F200 is 300 liters. Optionally available with a divisible hopper.

Target groups of F-Line F190/193-F200



- Medium-sized and industrial productions
- Large production of sausages
- Suitable for small calibrated products, which need a high filling pressure
- Users of conveyor linking systems BAS o2SA / KAS and AHL o2 systems
- Productions with high demands on the exactness of the portions and the quality
- Production of raw sausages with the grinding head system WK132/WK98
- Optimal suitable for all Frey C-Line components

Abbreviations	
PM	Portioning blade
DM	Double blade
FB	Forming belt
UTB	Universal transporting belt
CLB	C-Line belt
CLPS	C-Line portioning-cutting
PBSE	Portioning belt-cutting unit
WK	Grinding head
FT	Filling flow divider
PE	Paper interleaver
PES	Paper interleaver Stackler
PETD	Paper interleaver Tray Denester
TDL	Tray Denester Line
BF	Balformer
PF	Pattyformer
CL	Cevapcici line
BH	Burger head
UFK	Universal filling head
DK	Dosing piston
DSFK	Dosing station filling head
DS	Dosing station
TW	Tendancies weigher
KW	Check weigher
BAS	Belt linking system
SA	Servo linker
AHL	Hanging Line
KAS	Kebab linking system
KL	Kebab line
COEX	COEXtrusion
Linear	Electrical linear drive
OK	without option possible
X	not possible
EF	possible with limited function
CLIP	Option clipper socket necessary
CAN	CAN-Modul necessary
WK	WK drive necessary
SA	Option SA drive necessary
TW	Option TW socket necessary
KW	Option KW socket necessary
PC	Option PC socket necessary
ETH	Option ETH socket necessary
SCA	Special-clipper adapter necessary
	Individual module of an attachment

	Attachments		Filling stuffers													External device	
	Individual modules	Requirement	F40	F52	F60	F100/F103	F160/F163	F190/F193	F200	F222/F223	F260/F263	F266	KK500				
			TC100	TC266	TC266	TC266	TC733	TC266	TC733	TC733	TC733	TC733	TC733	TC733	TC733		
PM40			CLIP	OK	OK	OK	OK	OK	OK	OK	OK	OK	OK	OK	OK	OK	SCA
PM75 / PM100			CLIP	OK	OK	OK	OK	OK	OK	OK	OK	OK	OK	OK	OK	OK	SCA
PM Coex			X	OK	OK	OK	OK	OK	OK	OK	OK	OK	OK	OK	OK	OK	SCA
DM92		UTB30 o. CLB CAN o. CLB Linear															
DM92 linear		CLB Linear															
DM60-2		UTB30 o. CLB CAN o. CLB Linear															
DM60-2 linear		CLB Linear															
UTB 30			CLIP	OK	OK	OK	OK	OK	OK	OK	OK	OK	OK	OK	OK	OK	SCA
DMFB 90	UTB30 + DM92 + FB30/50		X	OK	OK	OK	OK	OK	OK	OK	OK	OK	OK	OK	OK	OK	SCA
FB30/50		UTB30 o. CLB CAN o. CLB Linear															
CLB CAN			X	CAN	CAN	CAN	CAN	CAN	CAN	CAN	CAN	CAN	CAN	CAN	CAN	CAN	X
DMFB 92 CAN	CLB CAN + DM92 + FB30/50		X	CAN	CAN	CAN	CAN	CAN	CAN	CAN	CAN	CAN	CAN	CAN	CAN	CAN	X
PMFB 100 CAN	CLB CAN + PM100 + FB30/50		X	CAN	CAN	CAN	CAN	CAN	CAN	CAN	CAN	CAN	CAN	CAN	CAN	CAN	X
DMFB60-2 CAN	CLB CAN + DM60-2 + FB30/50 + FT163-2		X	CAN	CAN	CAN	CAN	CAN	CAN	CAN	CAN	CAN	CAN	CAN	CAN	CAN	X
CLB Linear	CLB Linear + FB30/50		X	X	X	X	CAN	X	CAN	CAN	CAN	CAN	CAN	CAN	CAN	CAN	X
DMFB92 Linear	CLB Linear + DM92 Linear		X	X	X	X	CAN	X	CAN	CAN	CAN	CAN	CAN	CAN	CAN	CAN	X
DMFB60-2 Linear	CLB Linear + DM60-2 + FT163-2		X	X	X	X	CAN	X	CAN	CAN	CAN	CAN	CAN	CAN	CAN	CAN	X
CLPS320	CLB CAN + PBSE		X	CAN	CAN	CAN	CAN	CAN	CAN	CAN	CAN	CAN	CAN	CAN	CAN	CAN	X
PBSE		CLB CAN o. CLB Linear															
WK98			X	X	X	SA/WK	SA/WK	SA/WK	SA/WK	SA/WK	SA/WK	SA/WK	SA/WK	SA/WK	X	X	
WK132			X	X	X	X	X	X	X	WK	WK	WK	WK	WK	X	X	
FT162 / FT163			X	OK	OK	OK	OK	OK	OK	OK	OK	OK	OK	OK	OK	OK	
FTS162 / FTS163			X	OK	OK	OK	OK	OK	OK	OK	OK	OK	OK	OK	OK	OK	SCA/EF
FTDM ST	FT162 ST + DM		X	X	X	X	CAN	X	CAN	CAN	CAN	CAN	CAN	CAN	CAN	CAN	X
FTDM	FT162 + DM	CLB Linear															
PE160			X	OK	OK	OK	OK	OK	OK	OK	OK	OK	OK	OK	OK	OK	SCA/EF
PE160S			X	OK	OK	OK	OK	OK	OK	OK	OK	OK	OK	OK	OK	OK	SCA/EF
PETD 160			X	OK	OK	OK	OK	OK	OK	OK	OK	OK	OK	OK	OK	OK	SCA/EF
TDL60			X	OK	OK	OK	OK	OK	OK	OK	OK	OK	OK	OK	OK	OK	SCA/EF
BF50 / 70 / 100			X	OK	OK	OK	OK	OK	OK	OK	OK	OK	OK	OK	OK	OK	SCA/EF
CL6			OK	OK	OK	OK	OK	OK	OK	OK	OK	OK	OK	OK	OK	OK	
BH			OK	OK	OK	OK	OK	OK	OK	OK	OK	OK	OK	OK	OK	OK	
UFK			OK	OK	OK	OK	OK	OK	OK	OK	OK	OK	OK	OK	OK	OK	
DK20S / DK20F			CLIP/EF	OK	OK	OK	OK	OK	OK	OK	OK	OK	OK	OK	OK	OK	SCA/EF
DK40			OK	OK	OK	OK	OK	OK	OK	OK	OK	OK	OK	OK	OK	OK	SCA/EF
DK50/DK50F/DK50S			CLIP/EF	OK	OK	OK	OK	OK	OK	OK	OK	OK	OK	OK	OK	OK	SCA/EF
DK60			OK	OK	OK	OK	OK	OK	OK	OK	OK	OK	OK	OK	OK	OK	SCA/EF
DSFK			CLIP/EF	OK	OK	OK	OK	OK	OK	OK	OK	OK	OK	OK	OK	OK	SCA/EF
DS Station			X	OK	OK	OK	OK	OK	OK	OK	OK	OK	OK	OK	OK	OK	SCA/EF
TW Neptune CWP			X	X	TW	TW	TW	TW	TW	TW	TW	TW	TW	TW	TW	TW	SCA/EF
KW6-System			X	X	KW	KW	KW	KW	KW	KW	KW	KW	KW	KW	KW	KW	X
Metal detector			X	OK	OK	OK	OK	OK	OK	OK	OK	OK	OK	OK	OK	OK	SCA/EF
BAS02			X	X	X	X	CAN	X	CAN	CAN	CAN	CAN	CAN	CAN	CAN	CAN	X
BAS02 SA			X	X	X	X	CAN	X	CAN	CAN	CAN	CAN	CAN	CAN	CAN	CAN	X
AHL		BAS02 o. BAS02 SA o. KAS															
WS420			X	ETH	ETH	ETH	ETH	ETH	ETH	ETH	ETH	ETH	ETH	ETH	ETH	ETH	X
Hitec M-3X/F			X	PC	PC	PC	PC	PC	PC	PC	PC	PC	PC	PC	PC	PC	X
KAS			X	X	X	X	CAN	X	CAN	CAN	CAN	CAN	CAN	CAN	CAN	CAN	X
KL6			X	OK	OK	OK	OK	OK	OK	OK	OK	OK	OK	OK	OK	OK	SCA/EF
COEX			X	ETH	ETH	ETH	ETH	ETH	ETH	ETH	ETH	ETH	ETH	ETH	ETH	ETH	X

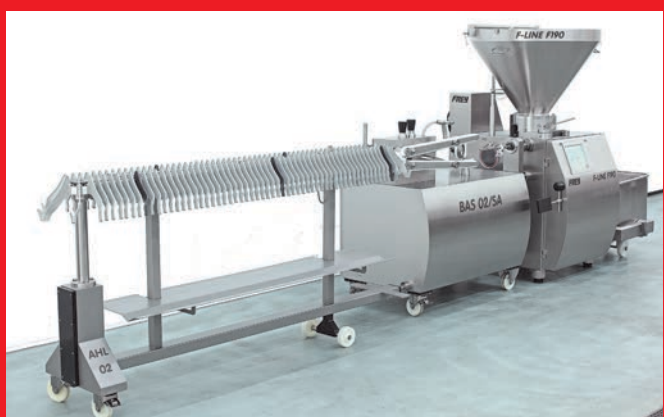

IPC control TC 266/733 with touch screen operation

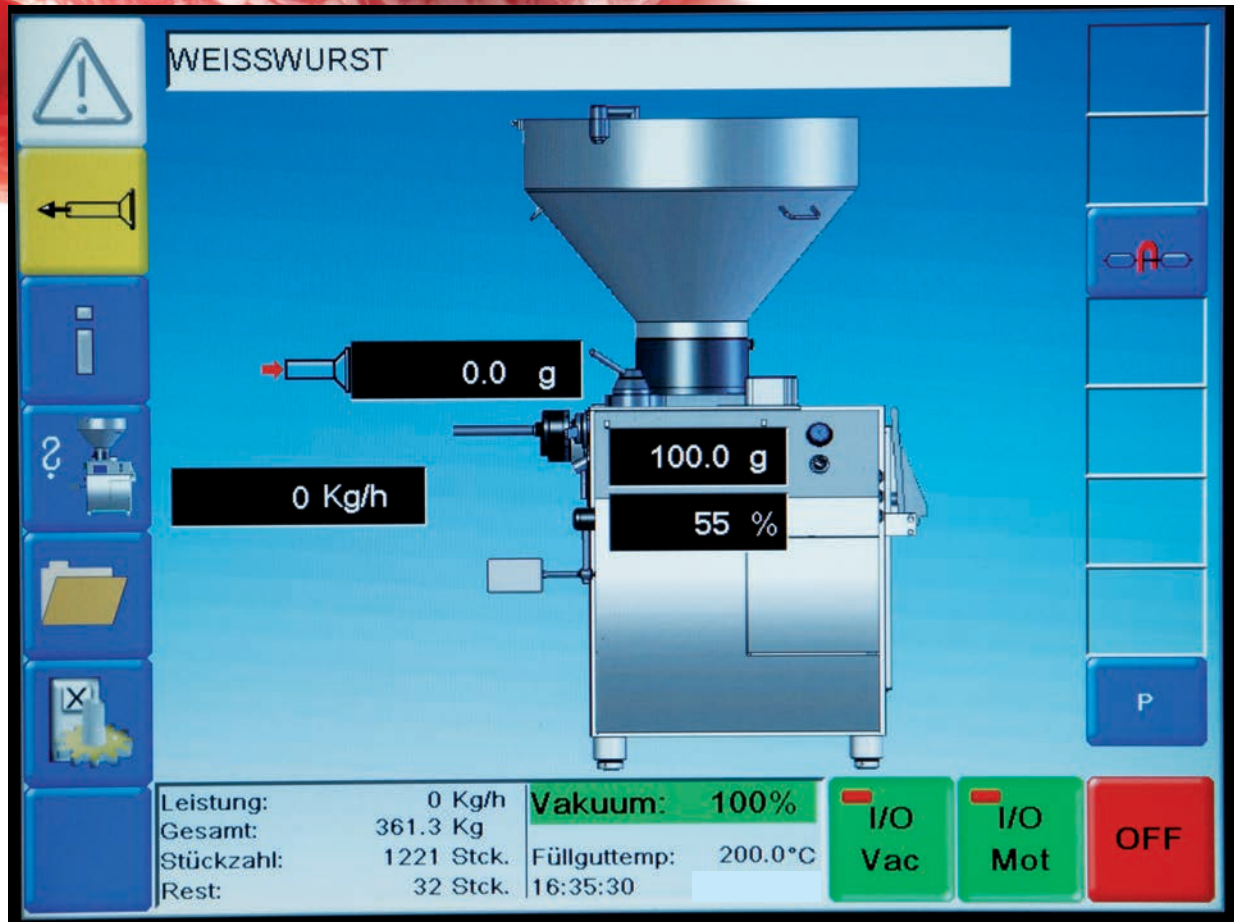

LAN/WLAN/VNC
Online connection



**Net remote
maintenance**
FREY-Service



The ultimate stuffer control system with all variety of functions consists of an industrial personal computer and a touch screen panel in the front door of the filling machine.

- solid hardware
- industrial PC with 733 MHz and an ergonomic 12" touch screen panel
- interfaces: CF Card, USB, Ethernet 10/100 Mbps
- online connection with your office pc via TCP/IP network connectivity
- powerful software without limits
- Logbook for the filling process and system incidents
- F-Line in connection with TC 266/733 meet the BDE standard of WS Food

TC733 - Survey of functions

- Weight input can be chosen between 0,1 and 100.000 g (from 0,0 - 999,9 g in 0,1g - steps)
- Number of links from 0 - 9,9 turns
- Preselection of pauses and clipping time
- Normal- and continuous operation
- 200 filling programs with table of contents
- Programs for cooked sausage
- Service- and maintenance programs
- Diagnosis programs
- Counter of quantity and pieces, preselection of pieces
- Twist delay / twist advance of the linker
- 1 st portion makeweight
- Speed control - infinitely variable also during the filling process
- Digital vacuum control optionally available is an electronic control valve for the stop of the machine and an automatic cleaning of the vacuum pump
- Automatic pressure regulation and torque regulation
- Electric pulse control for automatic clipping machines
- Relieve/sucking back mechanism
- Control of C-Line attachments
- Different languages adjustable
- Program administration with protection
- Software update per USB stick
- Interfaces: USB, Ethernet 10/100 Mbps
- Online connection with your office PC via TCP/IP connectivity
- Visualizing of the filling and linking process
- Logbook for the filling process & system incidents
- Optionally available: fill level indication

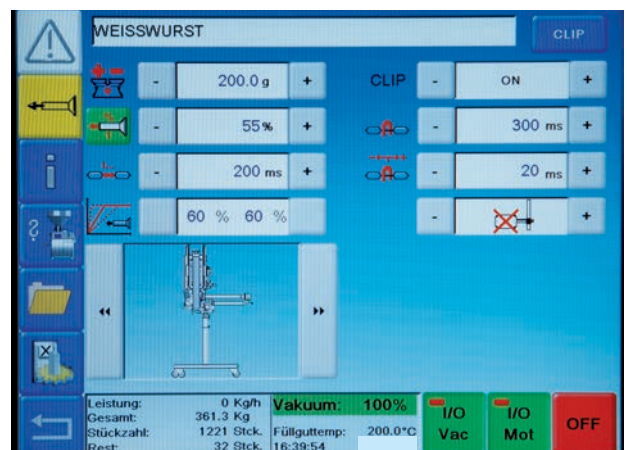
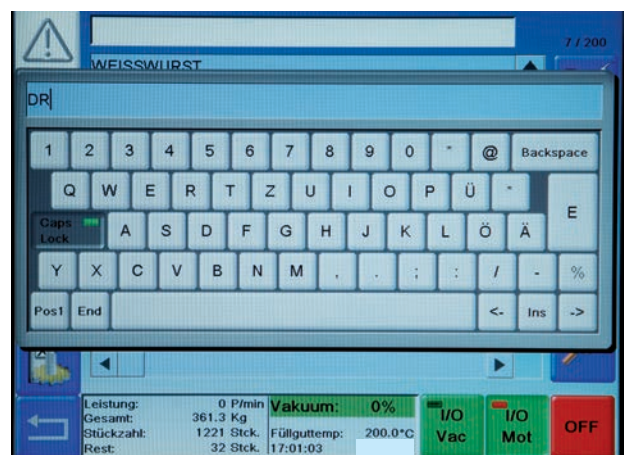
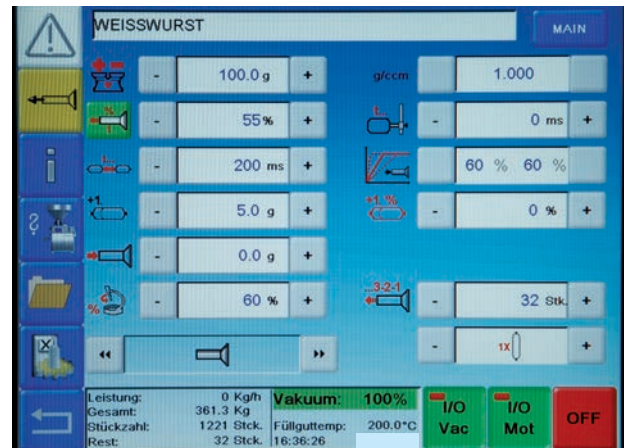

Interface/Connection

The filling machines will be integrated in your computer network. By this way you control your filling machines from your office. The connection is done via the Freeware Software VNC which offers a full functional diversity per telecontrol. You can do all settings on the machines from your office. Load or store filling programs. Only the starting and stopping function of the machine can be activated via the operating bar.

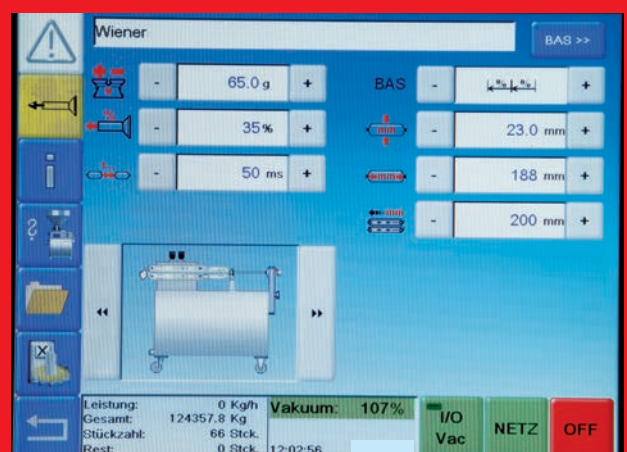



Increase the use of your F-Line

Casing holder device

A casing holder device DHGN for natural casings, which is easy in handling is available as an accessory for FREY vacuum stuffers. The casing holder device makes the filling process faster and easier. The casing holder DHGN2 was especially designed for natural casings. Using our casing holder devices you always get tight and solid sausages at maximum filling speed. Extra skilled staff is not required. The casing holder device is easy to assemble and can be taken off together with the linking gear. The casing tension is infinitely adjustable.

DHGA

Compared with the DHGN2 the DHGA is additionally equipped with a ceramic bearing with support for the casing holder tube (DHR) and the roller kit (ROKI). The casing holder device can also be used for collagen and cellulose casings. The DHGA ensures a continuous advance of the casing during the linking process. The DHGN2 and DHGA are maintenance-free because no drive is necessary.

Casing spooler

We offer pneumatic casing spoolers (DA-2012/DA-2013) for natural casings. They save time to increase the productivity of the filling station. In order to come up to your product diversity, you can order special filling tubes.

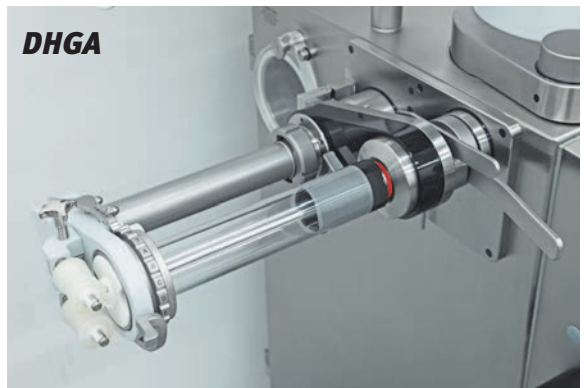

Services

Are nowadays more and more important. The reliability of our demonstrators and technicians stands for the high quality of FREY products. Our stuffers are well-thought out even in the smallest details. They are well-known for their long service life. Our trained staff gives you also advice by phone, fax or email in order to be able to help you immediately





Technical data

Technical data F-Line:

	F100	F103	F160	F163
Capacity of the filling hopper:	120 liters	120 liters	160 liters	160 liters
Max. performance:	3.600 Kg/h	3.000 Kg/h	3.600 Kg/h	3.000Kg/h
Filling pressure up to:	40 bar	55 bar	40 bar	55 bar
Capacity of the chambers:	82 g	82 g	82 g	82 g
Number of rotor vanes:	14	14	14	14
Portioning range:	5-100.000 g	5-100.000 g	5-100.000 g	5-100.000 g
Voltage / Tension:	400V/50Hz	400V/50Hz	400V/50Hz	400V/50Hz
Rotor system drive:	Servo	Servo	Servo	Servo
Stirrer drive:	gear	gear	gear	gear
Control type:	TC 266/733	TC 266/733	TC 733	TC 733
WS Food standard interface:	serial	serial	serial	serial
Total connected load max.:	9,5 KW	9,5 Kw	10,5 Kw	10,5 Kw
Suction power of the vacuum pump:	21 cbm/h	21 cbm/h	21 cbm/h	21 cbm/h
Machine weight (net)*:	650 Kg	650 Kg	885 Kg	885 Kg
Portioning speed max:	600 port/min.	600 port/min.	600 port/min.	600 port/min.

Technical data F-Line:

	F190	F193	F193WK	F200
Capacity of the filling hopper:	300 liters	300 liters	3000 liters	300 liters
Max. performance:	3.600 Kg/h	3.000 Kg/h	3.00 kg/h	4.200 Kg/h
Filling pressure up to:	40 bar	55 bar	55 bar	40 bar
Capacity of the chambers:	82 g	82 g	82 g	82 g
Number of rotor vanes:	14	14	14	14
Portioning range:	5-100.000 g	5-100.000 g	5-100.000 g	5-100.000 g
Voltage / Tension:	400V/50Hz	400V/50Hz	400V/50Hz	400V/50Hz
Rotor system drive:	Servo	Servo	Servo	Servo
Stirrer drive:	gear	gear	gear	gear
Control type:	TC 733	TC 733	TC733	TC733
WS Food standard interface:	serial	serial	serial	serial
Total connected load max.:	10,5 KW	10,5 Kw	13 Kw	12,0 Kw
Suction power of the vacuum pump:	21 cbm/h	21 cbm/h	21 cbm/h	21 cbm/h
Machine weight (net)*:	925 Kg	925 Kg	925 Kg	930 Kg
Portioning speed max:	600 port/min.	600 port/min.	600 port/min.	600 port/min.

Servo drive of the linker optionally available (necessary for WK98), special voltage on request (increase of weight up to 60 kg). Optionally available: electronic control valve of the vacuum system WK drive necessary for WK132 system.

Accessories: Rotor extractor, outlet cleaner, operating instructions, counter snake, accessories holder Filling tubes flange 73: 12/24/30/42 mm, flange 35: 14/20 mm

In order to come up to your product diversity, you can receive special filling tubes or other additional equipment from us, individually made for you. On the Frey accessories trolley all accessories find their place.

We would be pleased to inform you.



Drawings F100 - F200

Dimensions	F100 F103	F160 F163	F160 F163	F190 F193 F200
Hopper capacity	120l	160l	40/160l	300l
A	1740	1825	1810	1970
B	930	930	930	930
C	850	850	850	850
D	1300	1300	1300	1300
F	1885	1920	1965	2140
G	1115	1188	1200	1380
H	648	648	648	648
L	855	855	855	855
	-	Lifting device		
Trolley	-	120l	120l	200l
N	x	2805	2805	2995
O	x	1880	1880	2040
P	x	1745	1745	1870
R	x	1310	1310	1310

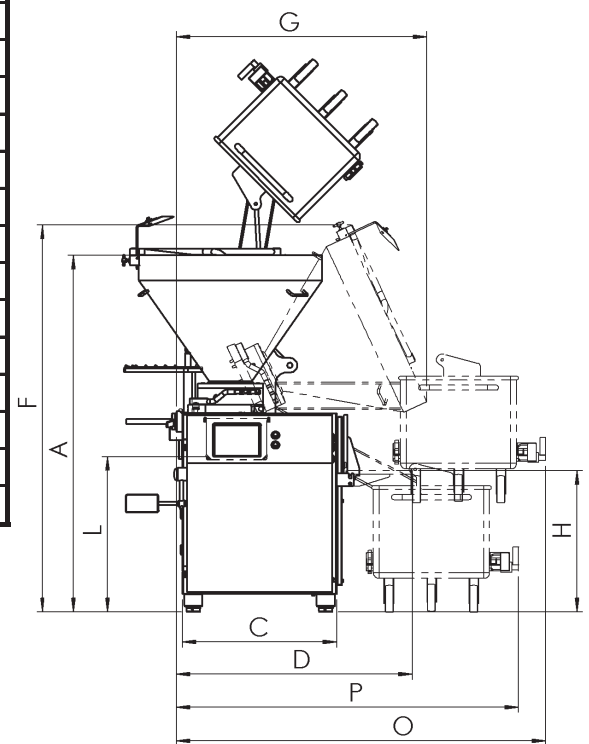
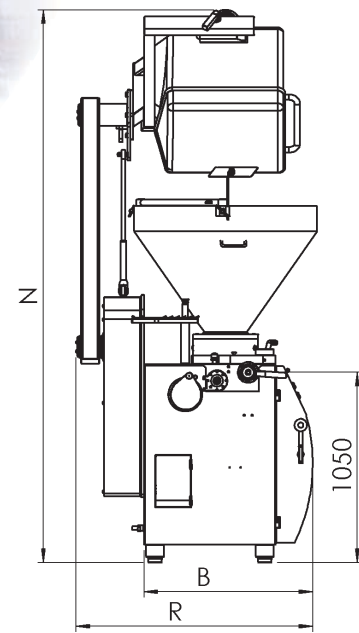

Heinrich Frey Maschinenbau GmbH

Fischerstr. 20
DE-89542 Herbrechtingen
Germany

Phone: +49 7324 172 0
Fax: +49 7324 172 44

www.frey-online.com
info@frey-online.com

Technical modifications are subject to change